

STROJE Slovensko s.r.o.

Zvolenská cesta 191, 97405 Banská Bystrica

tel: 048/4133184, 0905/603139, 0907/866745

Steff

Podávacie zariadenia / Power feeders Entraineurs
automatiques / Alimentadores automaticos



ANNIVERSARY
1963 - 2013

www.strojeslovensko.sk

Steff 2034

Steff 2048



Steff 2068

VarioSteff 4



Steff 2033

Steff 2032 Hobby

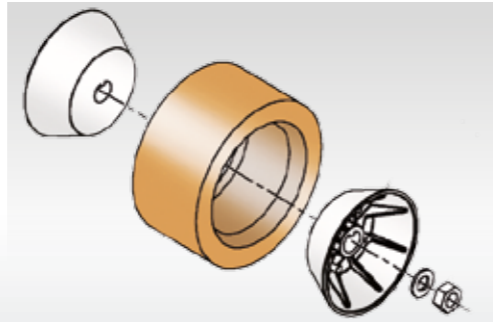
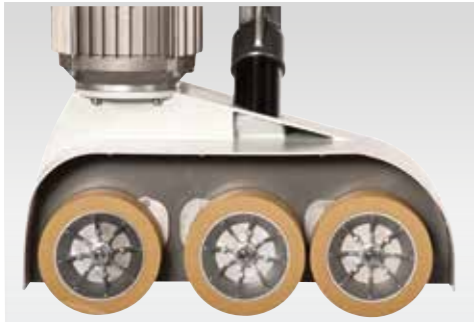

SHS
SYSTEM
Semi-Hub System



PIN
SYSTEM
Elastic Pin System

SPS
SYSTEM
Slip Proof System



feeder **GRIP**

THE GRIP REVOLUTION

Campione di aderenza

NUMBER ONE OF GRIP ADHESION
LE TOP EN ADHERENCE
CAMPEON EN ADHERENCIA

TECNOLOGIA BREVETTATA / PATENTED TECHNOLOGY / TECHNOLOGIE BREVETÉE / TECNOLOGIA PATENTADA

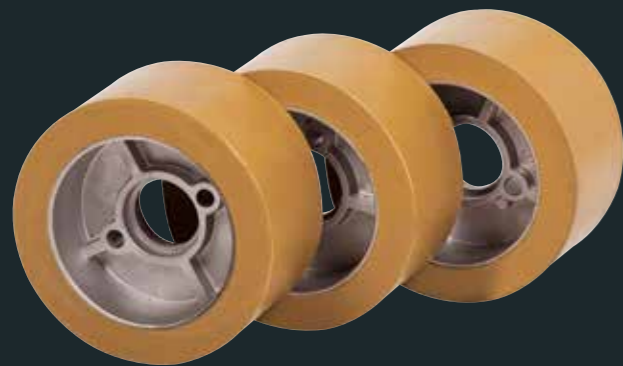

feeder **GRIP 758**

STANDARD

- Top dell'aderenza su ogni tipo di legno massello e multistrato
- Highest grip on any kind of solid wood and multilayer
- Le maximum d'adhérence sur bois massif et stratifié
- Adherencia maxima sobre todas las tipologias de madera maciza y de paneles multicapa de madera

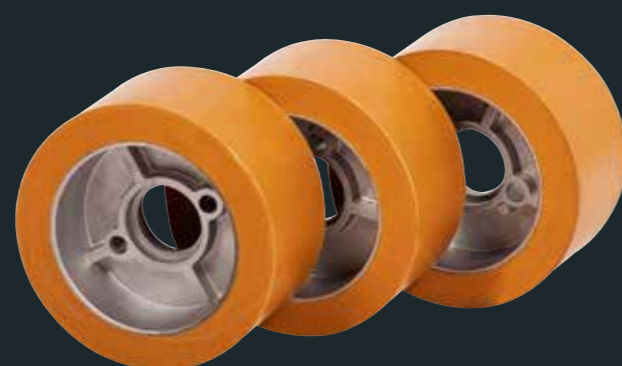

feeder **GRIP 363**

OPTIONAL

- Top dell'aderenza su materiale laminato e laccato
- Highest grip on any kind of laminated and painted material
- Le maximum d'adhérence sur matériel lamellé et laqué
- Adherencia maxima sobre paneles laminados y lacados



LA RIVOLUZIONE NEL MONDO DEL TRASCINAMENTO:

- TECNOLOGIA BREVETTATA
- TOP DELL'ADERENZA SU TUTTI I MATERIALI
- "BIO" BIODEGRADABILE CON GOMMA NATURALE
- "ECO" NOTEVOLE RISPARMIO ENERGETICO.

THE REVOLUTION IN THE WORLD OF POWER FEEDERS:

- PATENTED TECHNOLOGY
- THE HIGHEST GRIP ON ALL MATERIALS
- "BIO" BIODEGRADABLE WITH NATURAL RUBBER
- "ECO" SIGNIFICANT ENERGY SAVING.

LA REVOLUTION DANS LE MONDE DE L'ENTRAÎNEMENT:

- TECHNOLOGIE BREVETÉE
- LE MAXIMUM D'ADHÉRENCE SUR TOUS LES MATÉRIAUX
- "BIO" BIODÉGRADABLE AVEC CAOUTCHOUC NATUREL
- "ECO" ÉCONOMIE D'ÉNERGIE REMARQUABLE.

LA REVOLUCIÓN EN EL MUNDO DEL ARRASTRE:

- TECNOLOGIA PATENTADA
- ADHERENCIA MÁXIMA SOBRE TODO LOS MATERIALES
- "BIO" BIODEGRADABLE CON GOMA NATURAL
- "ECO" CONSIDERABLE AHORRO ENERGÉTICO.



Optional e ricambi

new

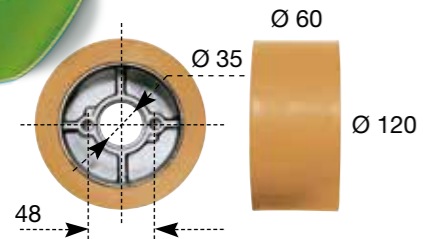

30100015 SHORE 50
feeder **GRIP** 758

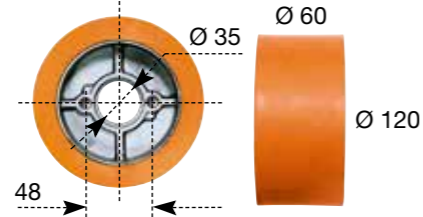

30102015 SHORE 40
feeder **GRIP** 363

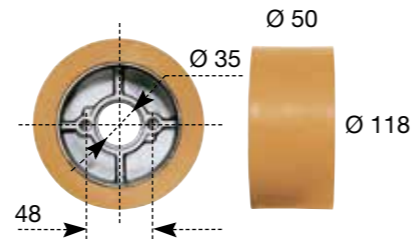

30100014 SHORE 65

STEFF 2033

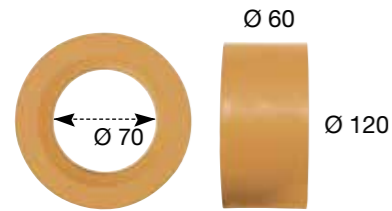

31301019 SHORE 50
feeder **GRIP** 758

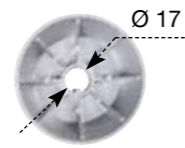

41300062
PER / FOR / POUR / PARA 31301019

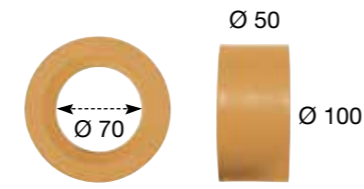

31500062 SHORE 50
feeder **GRIP** 758

STEFF 2032 HOBBY

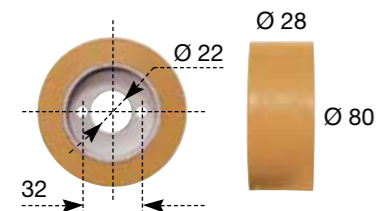

30000004 SHORE 50
feeder **GRIP** 758

STEFF 2038 CI



30200001 SHORE 45
feeder **GRIP** 758



41400011

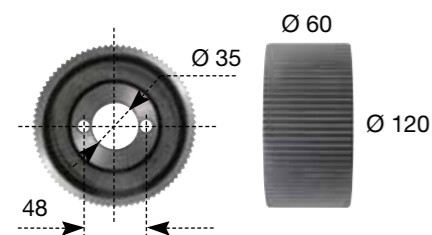

40102015



Optional and spare parts/Optional et pièces détachées/Accessorios y repuestos



STEFF 2034 / 2038 / 2044
2048 / 2068 / 2033 / V3 / V4

STEFF 2032



22100151



21401100

STEFF 2068



21100100



Universal stand



Esempi di lavorazione

Working examples/Exemples de travail/Ejemplos de trabajo

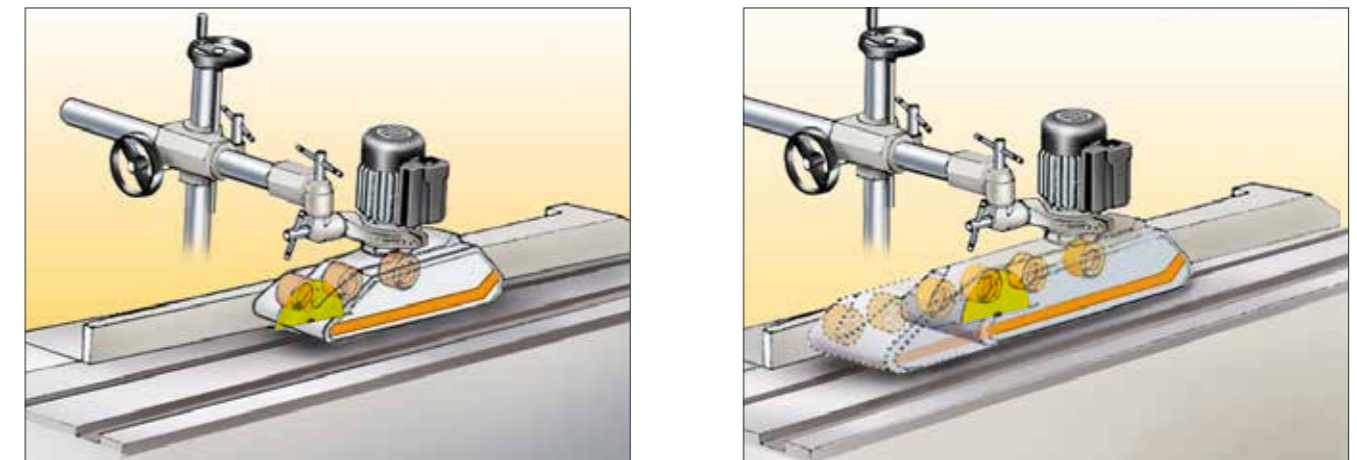

SEGA CIRCOLARE / CIRCULAR SAW / SCIE CIRCULAIRE / SIERRA CIRCULAR

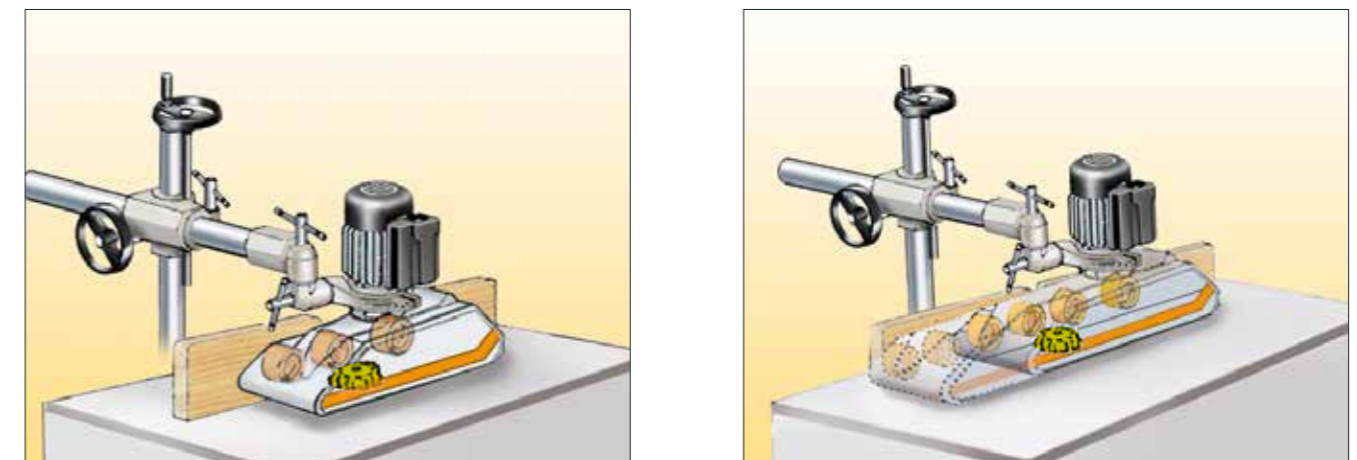



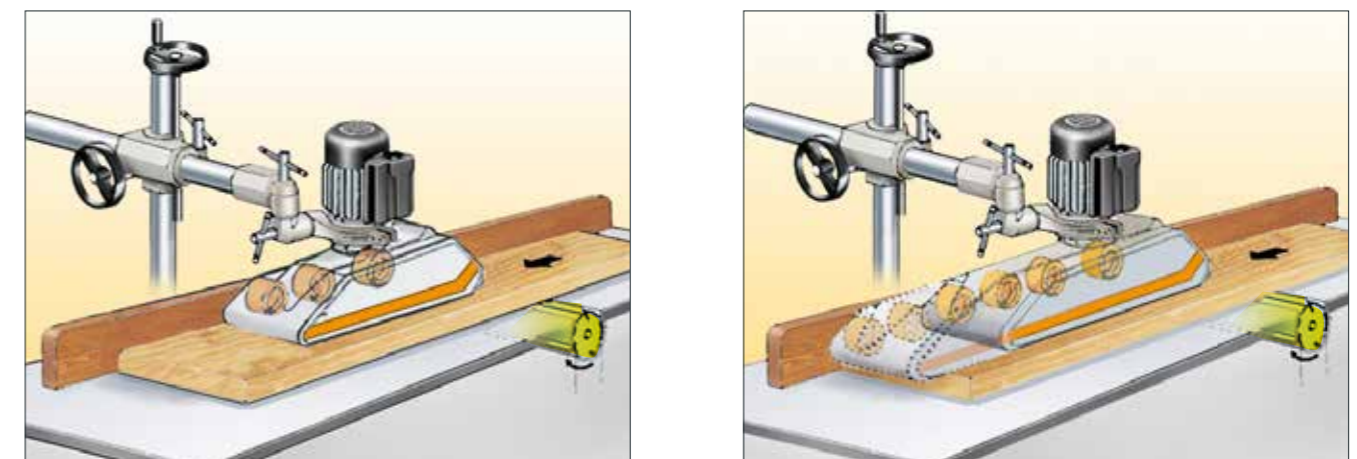





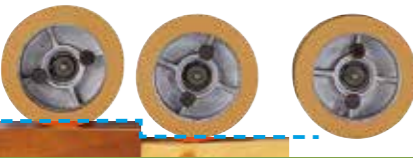

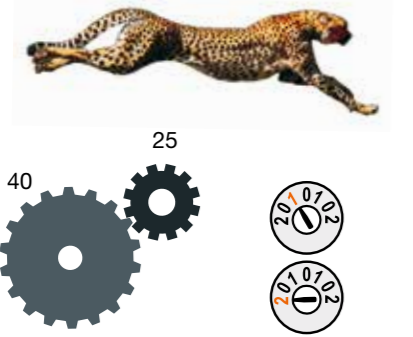



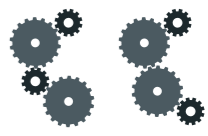
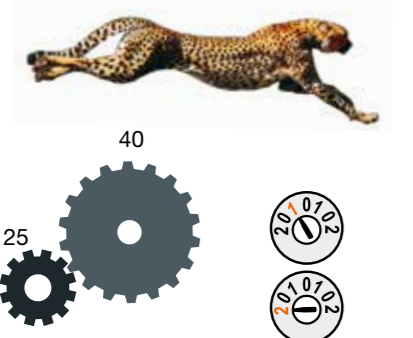



TOUPIE / SPINDLE MOULDER / POUPIE / TUPI

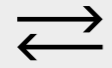
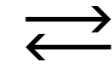
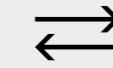
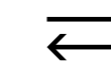
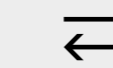
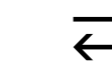

PIALLA A FILO / THICKNESS PLANER / DEGAUCHISSEUSE / CEPILLADORA

	Steff 2034 / 2038 / 2038 CI / 2044 / 2048 / 2068 / V3 / V4				Steff 2033	Steff 2032 Hobby
	STAND STANDARD	STAND 1050	STAND PLUS	STAND V		
	A 540 mm B 705 mm 35 kg	A 540 mm B 1050 mm 38,5 kg	A 540 mm B 1050 mm 40,5 kg	A 860 mm B 1050 mm 41 kg	A 525 mm B 655 mm -	A 460 mm B 660 mm -
	Ø 58 mm	Ø 58 mm	Ø 58 mm	Ø 58 mm	Ø 49 mm	Ø 40 mm
	Ø 58 mm	Ø 58 mm	Ø 58 mm	Ø 58 mm	Ø 49 mm	Ø 40 mm
	Ø 75 mm	Ø 75 mm	Ø 75 mm	Ø 75 mm		
	A 108 mm B 90 mm C 58 mm D 13 mm	A 108 mm B 90 mm C 58 mm D 13 mm	A 108 mm B 90 mm C 58 mm D 13 mm	A 108 mm B 90 mm C 58 mm D 13 mm	A 108 mm B 90 mm C 49 mm D 13 mm	A 63,8 mm B 63,8 mm C 40 mm D 9 mm
	800 x 330 x 330 mm 37 kg	1100 x 330 x 330 mm 41,5 kg	1100 x 330 x 330 mm 43,5 kg	110 x 330 x 330 mm 44 kg		

	Steff 2034	Steff 2038	Steff 2044	Steff 2048	Steff 2038 CI	Steff 2068	VarioSteff 3	VarioSteff 4	Steff 2032 hobby	Steff 2033
	3 Ø 120 x 60 mm	3 Ø 120 x 60 mm	4 Ø 120 x 60 mm	4 Ø 120 x 60 mm		6 Ø 120 x 60 mm	3 Ø 120 x 60 mm	4 Ø 120 x 60 mm	3 Ø 80 x 28 mm	3 Ø 120 x 60 mm
	20 mm	20 mm	20 mm	20 mm	20 mm	20 mm	20 mm	20 mm	15 mm	15 mm
					3 17 x 21 x 830 mm					
	N 4 4 m/min 8 m/min	N 8 I II 2 m/min 4 6,5 m/min 13	N 4 4 m/min 8 m/min	N 8 I II 2 m/min 4 6,5 m/min 13	N 8 I II 2 m/min 4 6,5 m/min 13	N 8 I II 2 m/min 4 6,5 m/min 13	VARIABLE VARIABLE  3 -18 m/min	VARIABLE VARIABLE  3 -18 m/min	N 4  4 m/min 8	N 8  3,2 m/min 12,5 6,3 m/min 25
	40 25 11 m/min 22 m/min	I II 5,5 m/min 11 16,5 m/min 33	11 m/min	I II 5,5 m/min 11 16,5 m/min 33	I II 5,5 m/min 11 16,5 m/min 33	I II 5,5 m/min 11 16,5 m/min 33	 3 -18 m/min	 3 -18 m/min	 9 m/min 18	 8,3 m/min 32 16,7 m/min 63
	HP 0,7 / 1 kW 0,52 / 0,75 1400 / 2800 / RPM 	HP 0,7 / 1 kW 0,52 / 0,75 1400 / 2800 / RPM 	HP 0,7 / 1 kW 0,52 / 0,75 1400 / 2800 / RPM 	HP 0,7 / 1 kW 0,52 / 0,75 1400 / 2800 / RPM 	HP 0,7 / 1 kW 0,52 / 0,75 1400 / 2800 / RPM 	HP 0,7 / 1 kW 0,52 / 0,75 1400 / 2800 / RPM 	HP 1 kW 0,75 1400 RPM 	HP 1 kW 0,75 1400 RPM 	HP 0,24 kW 0,18 1400 RPM 	HP 0,7 / 1 kW 0,52 / 0,75 1400 / 2800 / RPM 
	670 x 570 x 330 mm 31 kg	670 x 570 x 330 mm 32 kg	670 x 570 x 330 mm 35 kg	670 x 570 x 330 mm 36 kg	670 x 570 x 330 mm 32 kg	1000 x 560 x 340 mm 46 kg	670 x 570 x 330 mm 33 kg	670 x 570 x 330 mm 37 kg	670 x 560 x 340 mm 36 kg	680 x 570 x 340 mm 50 kg

www.strojeslovensko.sk



ANNIVERSARY
1963 - 2013

STROJE Slovensko s.r.o.

Zvolenská cesta č. 14437/191, 97405 Banská Bystrica

tel.: 048/4133184, 0905/603139, 0907/866745

e-mail: stroje@strojeslovensko.sk

www.strojeslovensko.sk



100% QUALITY
MADE IN ITALY

